



Features

- Epitaxial Planar Die Construction
- Ideal for Medium Power Amplification and Switching
- Complimentary PNP Type Available (DPLS320A)
- **Lead Free By Design/RoHS Compliant (Note 1)**
- “Green” Device (Note 2)
- **Qualified to AEC-Q101 Standards for High Reliability**

Mechanical Data

- Case: SOT-23
- Case Material: Molded Plastic, "Green" Molding Compound. UL Flammability Classification Rating 94V-0
- Moisture Sensitivity: Level 1 per J-STD-020D
- Terminals: Finish — Matte Tin annealed over Copper leadframe. Solderable per MIL-STD-202, Method 208
- Marking Information: See Page 3
- Ordering Information: See Page 3
- Weight: 0.008 grams (approximate)

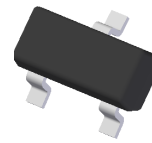

SOT-23

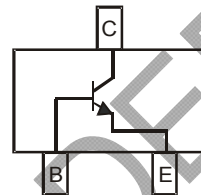

Schematic and Pin Configuration

Maximum Ratings @ $T_A = 25^\circ\text{C}$ unless otherwise specified

Characteristic	Symbol	Value	Unit
Collector-Base Voltage	V_{CBO}	20	V
Collector-Emitter Voltage	V_{CEO}	20	V
Emitter-Base Voltage	V_{EBO}	5	V
Peak Pulse Current	I_{CM}	5	A
Repetitive Peak Pulse Current (Note 3)	I_{CRP}	3	A
Continuous Collector Current	I_C	2	A
Base Current	I_B	0.5	A

Thermal Characteristics

Characteristic	Symbol	Value	Unit
Power Dissipation (Note 4) @ $T_A = 25^\circ\text{C}$	P_D	600	mW
Thermal Resistance, Junction to Ambient Air (Note 3) @ $T_A = 25^\circ\text{C}$	$R_{\theta JA}$	209	$^\circ\text{C}/\text{W}$
Operating and Storage Temperature Range	T_J, T_{STG}	-55 to +150	$^\circ\text{C}$

- Notes:
1. No purposefully added lead.
 2. Diodes Inc.'s "Green" policy can be found on our website at http://www.diodes.com/products/lead_free/index.php.
 3. Operated under pulse conditions: Pulse width $\leq 100\text{ms}$, duty cycle ≤ 0.25 .
 4. Device mounted on FR-4 PCB; pad layout as shown on page 4 or in Diodes Inc. suggested pad layout document AP02001, which can be found on our website at <http://www.diodes.com/datasheets/ap02001.pdf>.

Electrical Characteristics @T_A = 25°C unless otherwise specified

Characteristic	Symbol	Min	Typ	Max	Unit	Test Conditions
OFF CHARACTERISTICS (Note 5)						
Collector-Base Cutoff Current	I _{CBO}	—	—	100	nA	V _{CB} = 20V, I _E = 0
Emitter-Base Cutoff Current	I _{EBO}	—	—	50	μA	V _{CB} = 20V, I _E = 0, T _A = 150°C
Collector-Base Breakdown Voltage	V _{(BR)CBO}	20	—	—	V	I _C = 100μA
Collector-Emmitter Breakdown Voltage	V _{(BR)CEO}	20	—	—	V	I _C = 10mA
Emitter-Base Breakdown Voltage	V _{(BR)EBO}	5	—	—	V	I _E = 100μA
ON CHARACTERISTICS (Note 5)						
DC Current Gain	h _{FE}	220	—	—	—	V _{CE} = 2V, I _C = 0.1A
		220	—	—	—	V _{CE} = 2V, I _C = 0.5A
		220	—	—	—	V _{CE} = 2V, I _C = 1A
		200	—	—	—	V _{CE} = 2V, I _C = 2A
		150	—	—	—	V _{CE} = 2V, I _C = 3A
Collector-Emmitter Saturation Voltage	V _{CE(SAT)}	—	—	70	—	I _C = 0.5A, I _B = 50mA
		—	—	120	—	I _C = 1A, I _B = 50mA
		—	—	230	—	I _C = 2A, I _B = 40mA
		—	—	210	—	I _C = 2A, I _B = 200mA
		—	—	310	—	I _C = 3A, I _B = 300mA
Equivalent On-Resistance	R _{CE(SAT)}	—	85	105	mΩ	I _E = 2A, I _B = 200mA
Base-Emmitter Saturation Voltage	V _{BE(SAT)}	—	—	1.1	V	I _C = 2A, I _B = 40mA
		—	—	1.2	V	I _C = 3A, I _B = 300mA
Base-Emmitter Turn-on Voltage	V _{BE(ON)}	—	—	1.2	V	V _{CE} = 2V, I _C = 1A
SMALL SIGNAL CHARACTERISTICS						
Transition Frequency	f _T	100	220	—	MHz	V _{CE} = 5V, I _C = 100mA, f = 100MHz
Output Capacitance	C _{ob}	—	—	35	pF	V _{CB} = 10V, f = 1MHz

Notes: 5. Measured under pulsed conditions. Pulse width = 300μs. Duty cycle ≤2%.

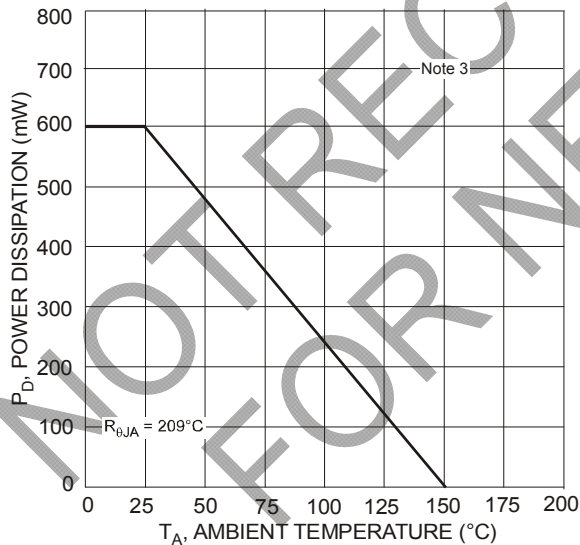

Fig. 1 Max Power Dissipation vs. Ambient Temperature

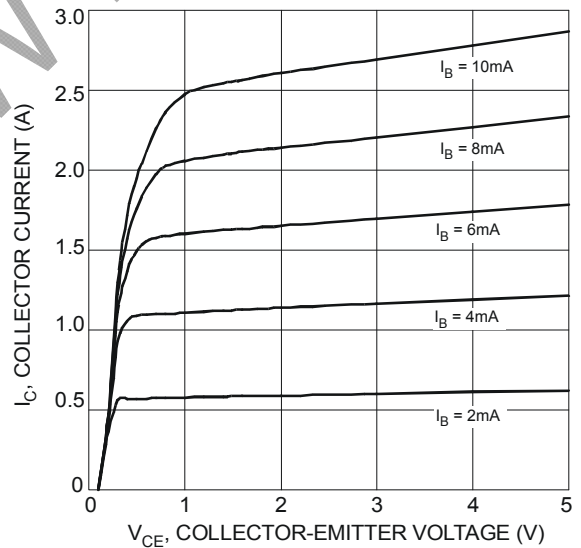

Fig. 2 Typical Collector Current vs. Collector-Emmitter Voltage

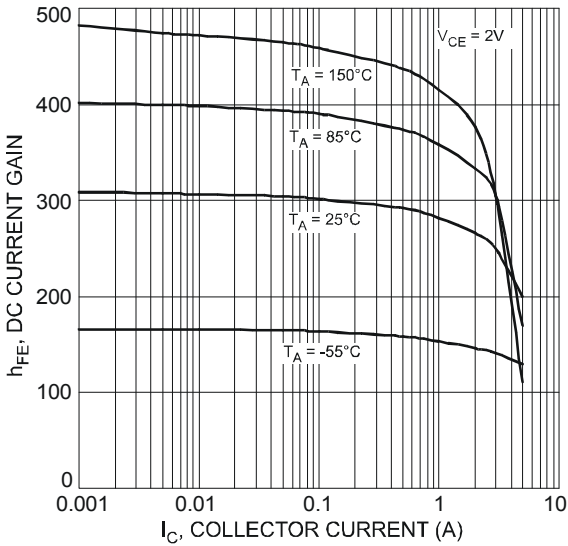

Fig. 3 Typical DC Current Gain vs. Collector Current

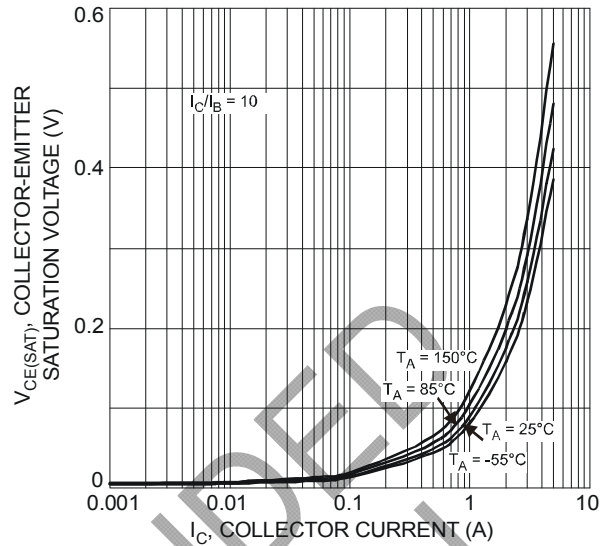

Fig. 4 Typical Collector-Emitter Saturation Voltage vs. Collector Current

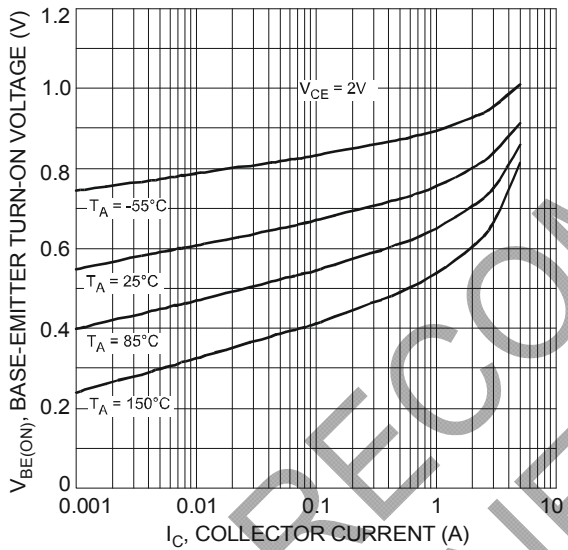

Fig. 5 Typical Base-Emitter Turn-On Voltage vs. Collector Current

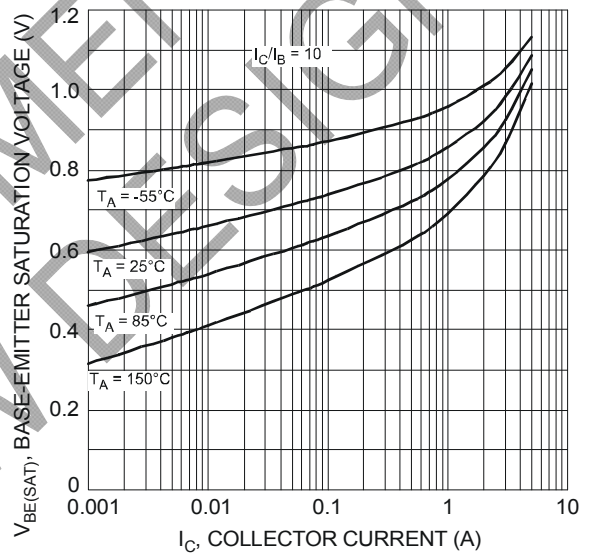

Fig. 6 Typical Base-Emitter Saturation Voltage vs. Collector Current

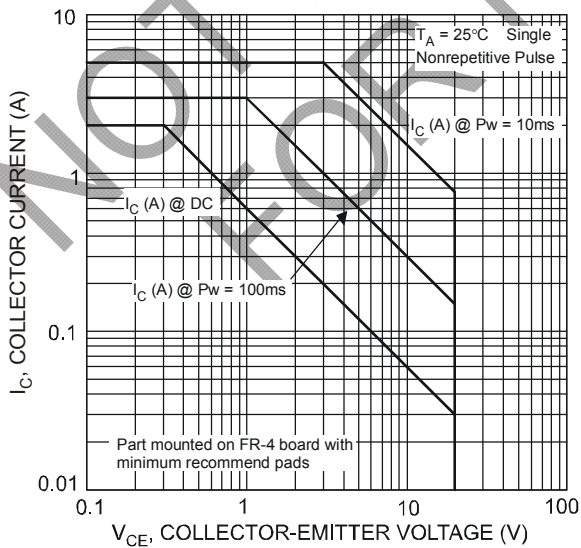

Fig. 7 Safe Operation Area

Ordering Information (Note 6)

Device DNLS320A-7	Packaging SOT-23	Shipping 3000/Tape & Reel
-----------------------------	----------------------------	-------------------------------------

Notes: 6. For packaging details, go to our website at <http://www.diodes.com/datasheets/ap02007.pdf>.

Marking Information

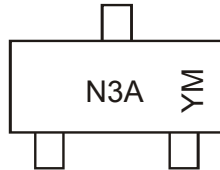

N3A = Product Type Marking Code
YM = Date Code Marking
Y = Year (ex: V = 2008)
M = Month (ex: 9 = September)

Date Code Key

Year	2008	2009	2010	2011	2012	2013	2014	2015
Code	V	W	X	Y	Z	A	B	C

Month	Jan	Feb	Mar	Apr	May	Jun	Jul	Aug	Sep	Oct	Nov	Dec
Code	1	2	3	4	5	6	7	8	9	O	N	D

Package Outline Dimensions

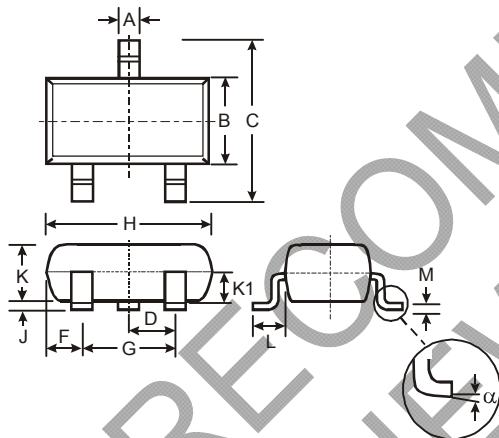

SOT-23			
Dim	Min	Max	Typ
A	0.37	0.51	0.40
B	1.20	1.40	1.30
C	2.30	2.50	2.40
D	0.89	1.03	0.915
F	0.45	0.60	0.535
G	1.78	2.05	1.83
H	2.80	3.00	2.90
J	0.013	0.10	0.05
K	0.903	1.10	1.00
K1	-	-	0.400
L	0.45	0.61	0.55
M	0.085	0.18	0.11
α	0°	8°	-
All Dimensions in mm			

Suggested Pad Layout

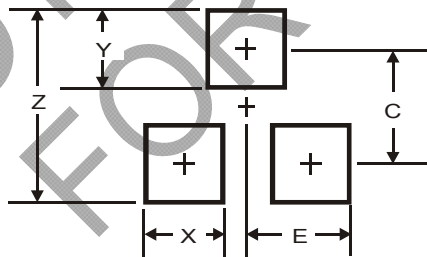

Dimensions	Value (in mm)
Z	2.9
X	0.8
Y	0.9
C	2.0
E	1.35

IMPORTANT NOTICE

Diodes Incorporated and its subsidiaries reserve the right to make modifications, enhancements, improvements, corrections or other changes without further notice to any product herein. Diodes Incorporated does not assume any liability arising out of the application or use of any product described herein; neither does it convey any license under its patent rights, nor the rights of others. The user of products in such applications shall assume all risks of such use and will agree to hold Diodes Incorporated and all the companies whose products are represented on our website, harmless against all damages.

LIFE SUPPORT

Diodes Incorporated products are not authorized for use as critical components in life support devices or systems without the expressed written approval of the President of Diodes Incorporated.